

UNIMOTION

STEPPER SYSTEMS
MOTORS, DRIVES,
CABLES



About Us

UNIMOTION is a leading company in the industrial automation field, at a global level. Combining innovative engineering solutions – Unimotion helps companies of all sizes across a wide range of industrial segments. Unimotion develops Industry 4.0-enabled products and systems with leading quality, performance and value. Engineering, Production, Construction, Warehouse, Research & Development department; all this can be found under one roof. Thanks to years of experience and a consistent focus on automation technology, we are continually improving our products and implementing innovations that provide customers with many technical advantages. Our core values are precision, innovation, passion, and integrity. At Unimotion, our main goal is the satisfaction of every single customer with a commitment to deliver the impossible.

Unimotion sales team, technicians and experts are at your disposal to provide customized expertise and support. We look forward to meeting you and work on your special project.



Table of Contents

General overview	4
Possible drive-motor-cable combinations	5
Speed-torque characteristics of possible drive-motor combinations	6
Connections showcase	6
Drives	7
How to order	8
Pulse-direction	8
EtherCAT	12
Ethernet	16
Profinet	20
Motors	24
How to order	25
STMN-42-L-E(-B)	25
STMN-56-L-E(-B)	27
Cables	29
How to order	30
Power cable	31
Signal cable	31
Drive-to-motor cables	33

General overview

Possible drive-motor-cable combinations	5
Speed-torque characteristics of possible drive-motor combinations	6
Connections showcase	6

UNIMOTION stepper motors and drives offer a simple solution for precise automation, available with Ethernet, EtherCAT, Pulse-direction or Profinet communication so that each application can be personalised according to individual specifications.



POSSIBLE DRIVE-MOTOR-CABLE COMBINATIONS

In the table available motor-drive-cable combinations are shown.

Stepper motor			Drive		Driver-to-motor cable		
Size [mm]	Brake	Code	Protocol/control	Code	Motor	Brake	Encoder
□42	-	STMN-42-L-E	EtherCAT	STDF-42-A-EC	STCF-M-12-...	-	STCF-E-12-...
			Ethernet	STDF-42-A-EN			
			Pulse-direction	STDF-42-A-PD			
			Profinet	STDL-40-C-PN			
	with	STMN-42-L-E-B	EtherCAT	STDF-42-A-EC	STCF-M-12-...	STCF-B-8-...	STCF-E-12-...
			Ethernet	STDF-42-A-EN			
			Pulse-direction	STDF-42-A-PD			
			Profinet	STDL-40-C-PN			
□56	-	STMN-56-L-E	EtherCAT	STDF-56-A-EC	STCF-M-12-...	-	STCF-E-12-...
			Ethernet	STDF-56-A-EN			
			Pulse-direction	STDF-56-A-PD			
			Profinet	STDL-040-C-PN			
	with	STMN-56-L-E-B	EtherCAT	STDF-56-A-EC	STCF-M-12-...	STCF-B-8-...	STCF-E-12-...
			Ethernet	STDF-56-A-EN			
			Pulse-direction	STDF-56-A-PD			
			Profinet	STDL-040-C-PN			

SPEED-TORQUE CHARACTERISTICS OF POSSIBLE DRIVE-MOTOR COMBINATIONS

i On the following diagrams torque as a function of speed is presented for each motor with appropriate drive.

STMN-42-L-E(-B) with STDF-42-A-.. or STDL-040-A-PN

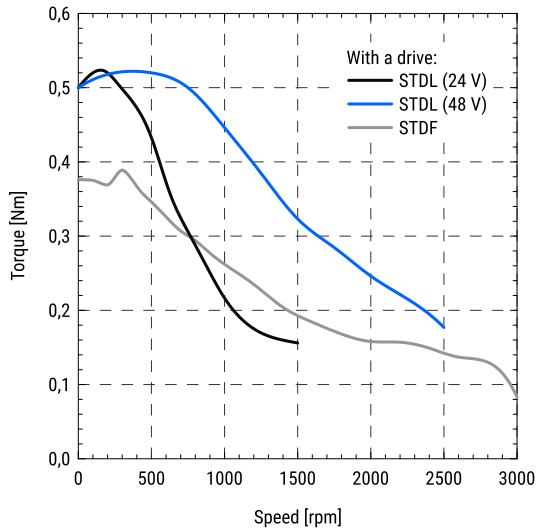

STMN-56-L-E(-B) with STDF-65-A-.. or STDL-040-A-PN

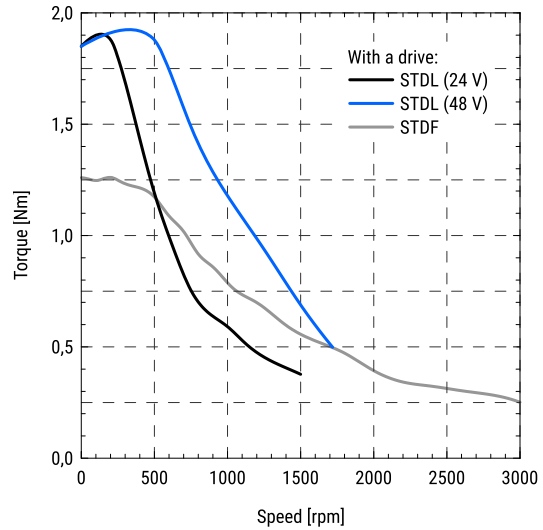

CONNECTIONS SHOWCASE

No.	Accessories	Page
1	Motor	24
2	Drive	7
3	Motor cable	35
4	Brake cable	36
5	Signal cable	31
6	Power cable	31
7	Encoder cable	33

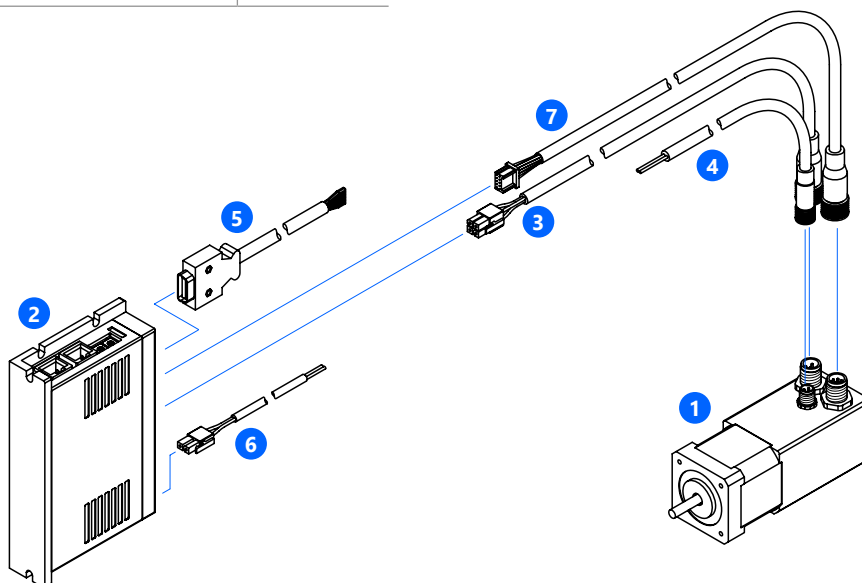

Drives

How to order	8
Pulse-direction	8
EtherCAT	12
Ethernet	16
Profinet	20

HOW TO ORDER

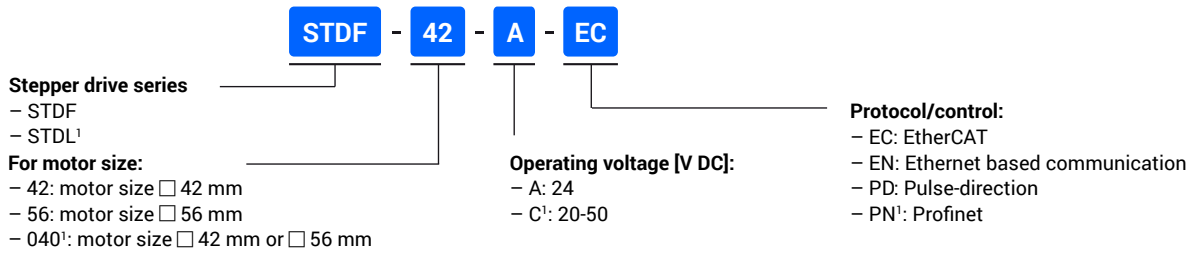

¹ only available with Profinet communication, operating voltage option C and motor size option 040.

i For possible combinations refer to the table POSSIBLE DRIVE-MOTOR-CABLE COMBINATIONS, column Drive/Code.

PULSE-DIRECTION

Description

Pulse-direction refers to a type of digital signalling, used in position control. There are two types of pulse control:

1. 1-signal mode (Pulse/Mode)
2. 2-signal mode (CW/CCW)

This mode has CW and CCW inputs. The pulse at these inputs determines whether the motor rotates clockwise or counterclockwise.

It contains two signals, one for distance and speed, and the other for the direction of rotation. The actual movement is carried out by pulses received from the controller, i.e. can be arbitrarily set to be for one revolution of the motor, 1000 pulses.

Other advantages are:

- No gain tuning / No hunting
- Heat reduction / Torque improvement
- Plug & Drive (no tuning necessary)
- Brake control
- DIN rail mounting option
- RoHS directive
- EMC directive
- Closed-loop system (errors are corrected)



Dimensions

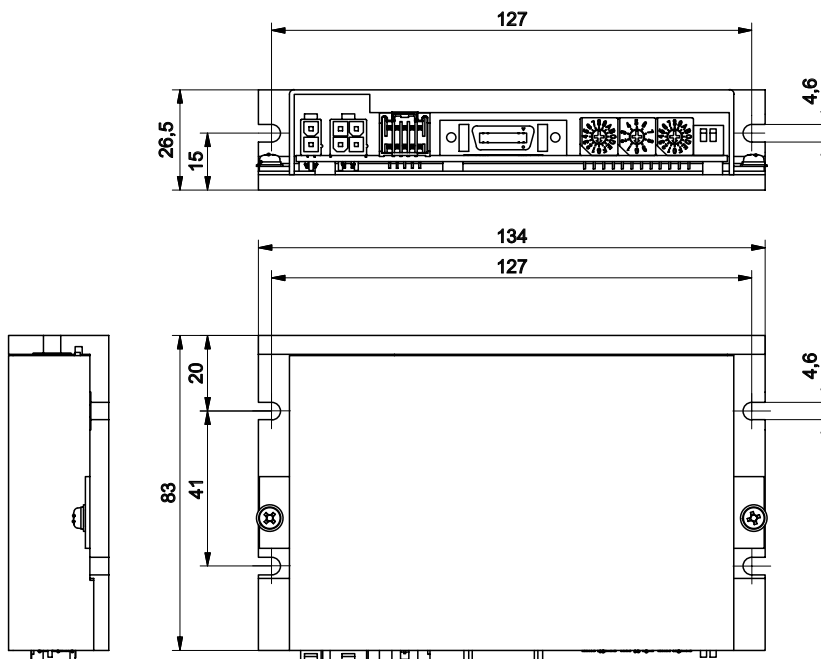

i All dimensions are in mm. The scale of the drawings may not be equal.

General technical data

PARAMETER	Type	Stepper drive
	Protocol/control	Pulse-direction control
	Code	STDF-PD
	UNIT	VALUE
Operating voltage	[V DC]	24 ± 10 %
Current consumption ¹	[mA]	max. 500
Rotational speed	[rpm]	Refer to chapter: SPEED-TORQUE CHARACTERISTICS
Supported resolution ²	[ppr]	500, 1000, 1600, 2000, 3600, 5000, 7200, 10000
Input signals		Position command pulse
		Servo on/off
		Alarm reset (Photocoupler input)
Output signals		In-position
		Alarm (Photocoupler output)
		Encoder signal, brake
Ambient temperature	[°C]	0 ~ +50
Ambient humidity	[%]	35 ~ 80 (non-condensing)
Vibration resistance	[G]	0,5
Duty cycle	[%]	100

¹ Except the motor current.

² For the case that resolution is higher than the encoder's resolution, the motor shall operate by micro-step between pulses.

Calculation of sufficient power supply:

$$P_{Wmax} = (I_d + I_{ph}) \cdot U_m$$

I_{ph}	Motor phase current	[A]
I_d	Drive current	[A]
U_m	Power supply voltage	[V]
P_{Wmax}	Maximum required power supply	[W]

i Required power supply P_w is at maximum load of the stepper motor.

Port and indicator information

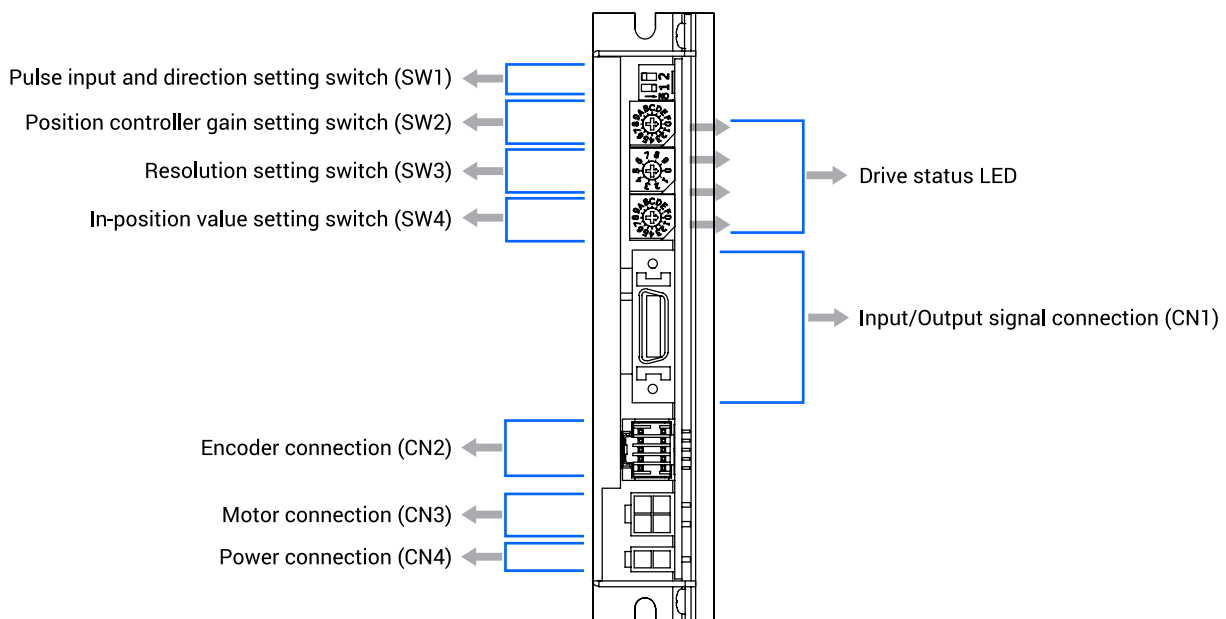

Pin layout

Input/Output signal connector (CN1):

No.	Function	I/O
1	CW+ (Pulse+)	Input
2	CW- (Pulse-)	Input
3	CCW+ (Dir+)	Input
4	CCW- (Dir-)	Input
5	A+	Output
6	A-	Output
7	B+	Output
8	B-	Output
9	I+	Output
10	I-	Output
11	Alarm	Output
12	In-position	Output
13	Servo on/off	Input
14	Alarm reset	Input
15	Open collector input	Input
16	BRAKE+	Output
17	BRAKE-	Output
18	S-GND	Output
19	EXT_GND	Input
20	EXT_24VDC	Input

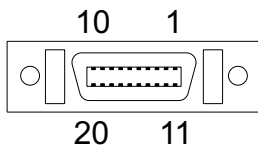

Motor connector (CN3):

No.	Function	I/O
1	A+ Phase	Output
2	B+ Phase	Output
3	A- Phase	Output
4	B- Phase	Output

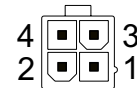

Power connector (CN4):

No.	Function	I/O
1	24 V (DC)	Input
2	GND	Input



Encoder connector (CN2):

No.	Function	I/O
1	A+	Input
2	A-	Input
3	B+	Input
4	B-	Input
5	I+	Input
6	I-	Input
7	5 V (DC)	Output
8	GND	Output
9	F.GND	-
10	F.GND	-

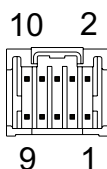

External wiring diagram

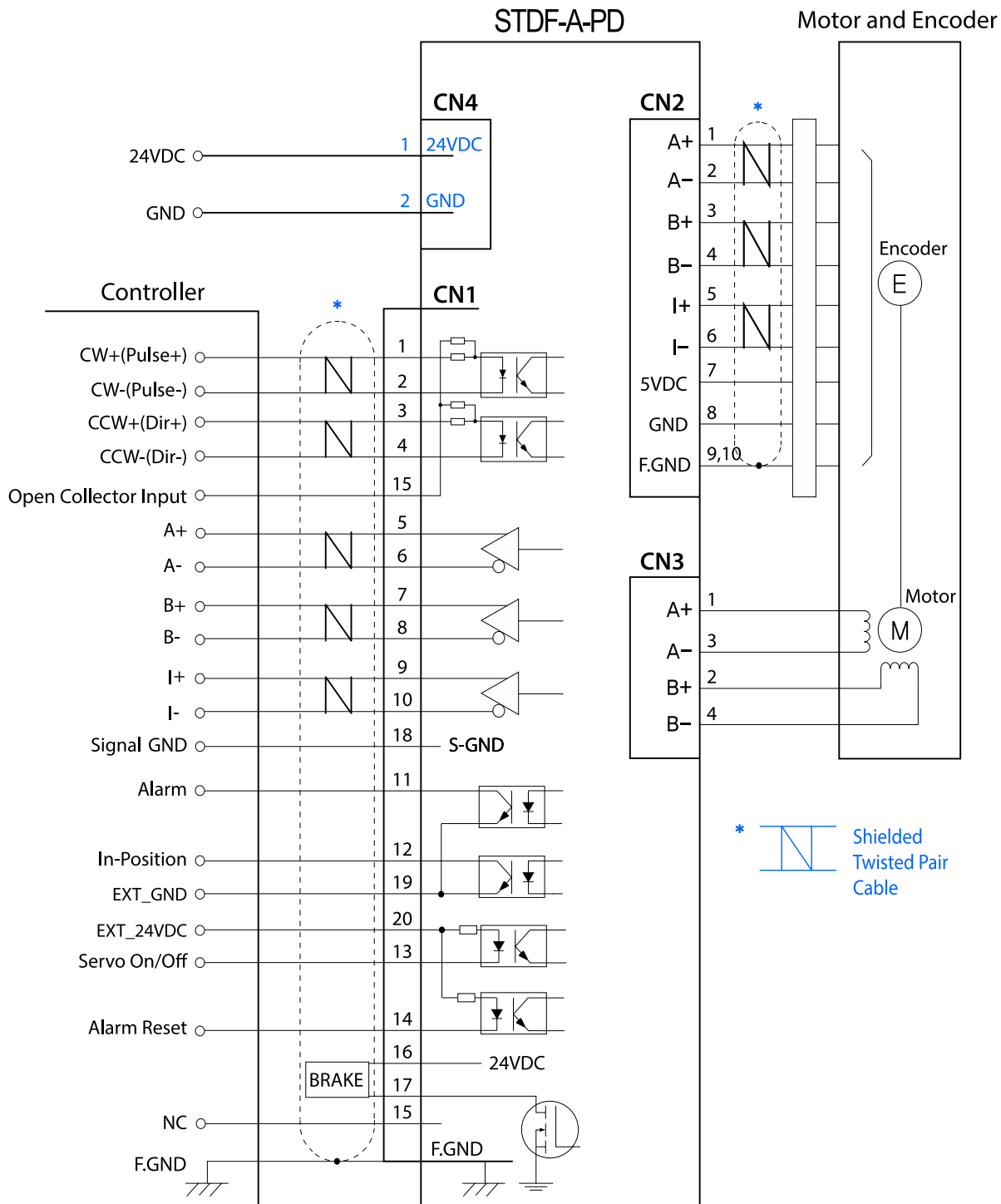

CAUTION
Please refer to the Manual when connecting the motor extension cable.
Careful connection will be required to protect the drive from any damages.

※ When connecting the I/O cables between the controller and drive, please turn off the power of both controller and drive to protect the drive from any damage.

ETHERCAT

Description

EtherCAT is the fastest Industrial Ethernet technology. This is a huge benefit for all applications in which the target system is controlled or measured via the bus system. The rapid reaction times work to reduce the wait times during the transitions between process steps, which significantly improves application efficiency.

Other advantages:

- CiA 402 Drive Profile Support
- Closed-loop system (errors are corrected)
- No Gain Tuning / No Hunting
- Heat Reduction / Torque Improvement
- Plug & Drive (no tuning necessary)
- Brake control
- DIN rail mount option
- RoHS directive
- EMC directive



Dimensions

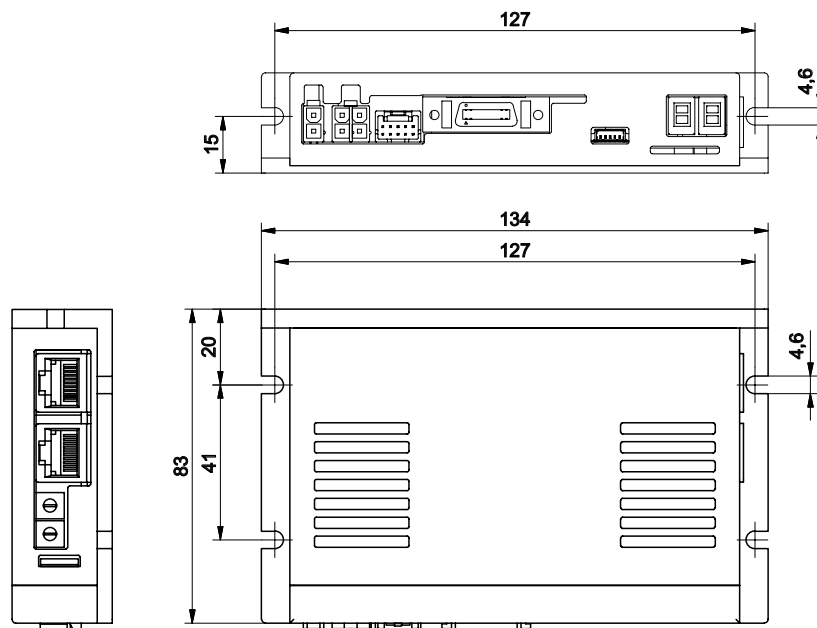

i All dimensions are in mm.
The scale of the drawings
may not be equal.

General technical data

PARAMETER	Type	Stepper drive
	Protocol/control	EtherCAT
	Code	STDF-EC
	UNIT	VALUE
Operating voltage	[V DC]	24 ± 10 %
Current consumption ¹	[mA]	max. 500
Rotational speed	[rpm]	Refer to chapter: SPEED-TORQUE CHARACTERISTICS
Supported resolution ²	[ppr]	500, 1000, 1600, 2000, 3600, 5000, 7200, 10000
Input signals		3 dedicated inputs (LIMIT+, LIMIT-, ORIGIN) 7 user inputs (Photocoupler)
Output signals		6 user outputs (Photocoupler) Brake
Ambient temperature	[°C]	0 ~ +50
Ambient humidity	[%]	35 ~ 80 (non-condensing)
Vibration resistance	[G]	0,5
Duty cycle	[%]	100

¹ Except the motor current.

² For the case that resolution is higher than the encoder's resolution, the motor shall operate by micro-step between pulses.

Calculation of sufficient power supply:

$$P_{Wmax} = (I_d + I_{ph}) \cdot U_m$$

I_{ph}	Motor phase current	[A]
I_d	Drive current	[A]
U_m	Power supply voltage	[V]
P_{Wmax}	Maximum required power supply	[W]

i Required power supply P_w is at maximum load of the stepper motor.

Port and indicator information

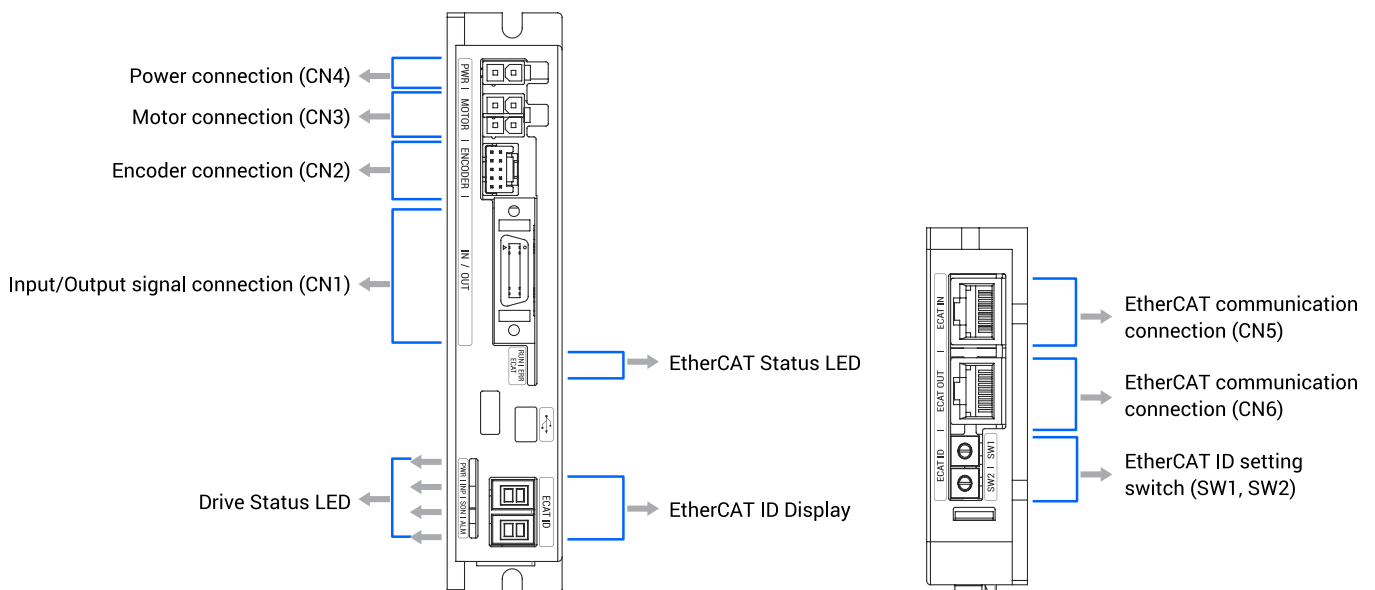

Pin layout

Input/Output signal connector (CN1):

No.	Function	I/O
1	LIMIT+	Input
2	LIMIT-	Input
3	ORIGIN	Input
4	Digital In1	Input
5	Digital In2	Input
6	Digital In3	Input
7	Digital In4	Input
8	Digital In5	Input
9	Digital In6	Input
10	Digital In7	Input
11	Digital Out1	Output
12	Digital Out2	Output
13	Digital Out3	Output
14	Digital Out4	Output
15	Digital Out5	Output
16	Digital Out6	Output
17	BRAKE+	Output
18	BRAKE-	Output
19	EXT_GND	Input
20	EXT_24VDC	Input

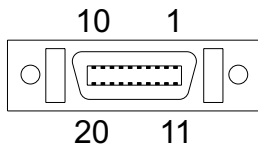

EtherCAT ID display and settings switch (SW1, SW2):

There are two rotary switches for setting the value of the EtherCAT ID (ECAT Device ID) on the side of the device. The right switch (SW1) sets the »ones« (X1), while the switch on the left (SW2) sets the »tens« (X10). Set values are displayed on »ECAT ID« segment display.

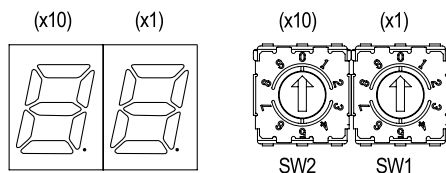

Encoder connector (CN2):

No.	Function	I/O
1	A+	Input
2	A-	Input
3	B+	Input
4	B-	Input
5	I+	Input
6	I-	Input
7	5 V (DC)	Output
8	GND	Output
9	F.GND	-
10	F.GND	-

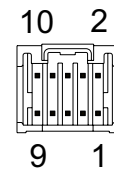

Motor connector (CN3):

No.	Function	I/O
1	A+ Phase	Output
2	B+ Phase	Output
3	A- Phase	Output
4	B- Phase	Output

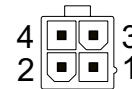

Power connector (CN4):

No.	Function	I/O
1	24 V (DC)	Input
2	GND	Input



EtherCAT communication connector (CN5, CN6):

No.	Function
1	TD+
2	TD-
3	RD+
4	-
5	-
6	RD-
7	-
Connection hood	F.GND

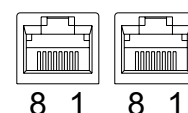

External wiring diagram

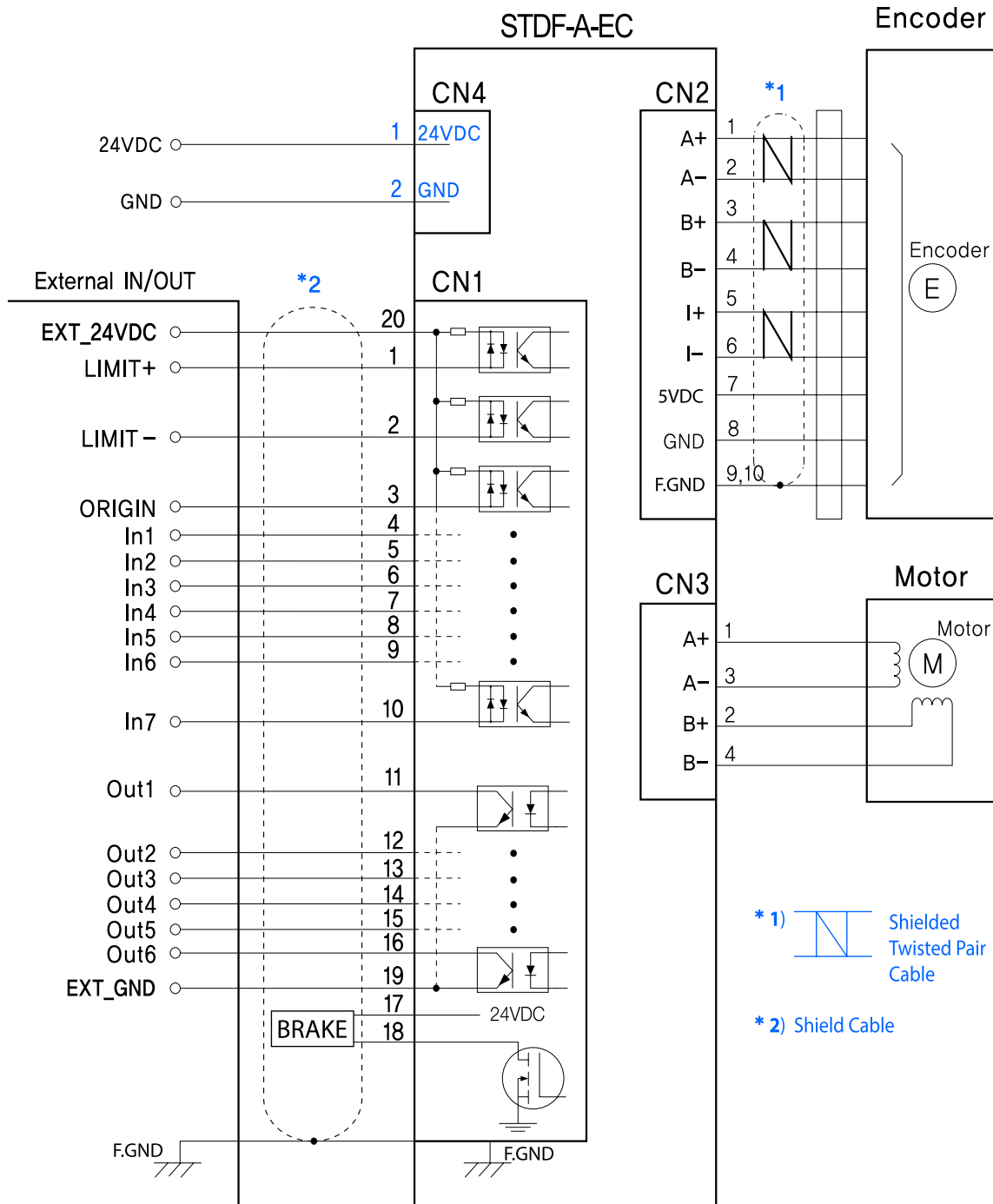

CAUTION

Please refer to the Manual when connecting the motor extension cable.

Carefull connection will be required to protect the drive from any damages.

※ When connecting the I/O cables between the controller and drive, please turn off the power of both controller and drive to protect the drive from any damage.

ETHERNET

Description

Ethernet is the standard communication protocol used to connect devices. It is the most widely used technology for local area networking and allows TCP or UDP protocol for sending data (possible to control it with Siemens S7 PLC).

Other advantages:

- Closed-loop system (errors are corrected)
- No Gain Tuning / No Hunting
- Heat Reduction / Torque Improvement
- Plug & Drive (no tuning necessary)
- Brake control
- DIN rail mount option
- RoHS directive
- EMC directive



Dimensions

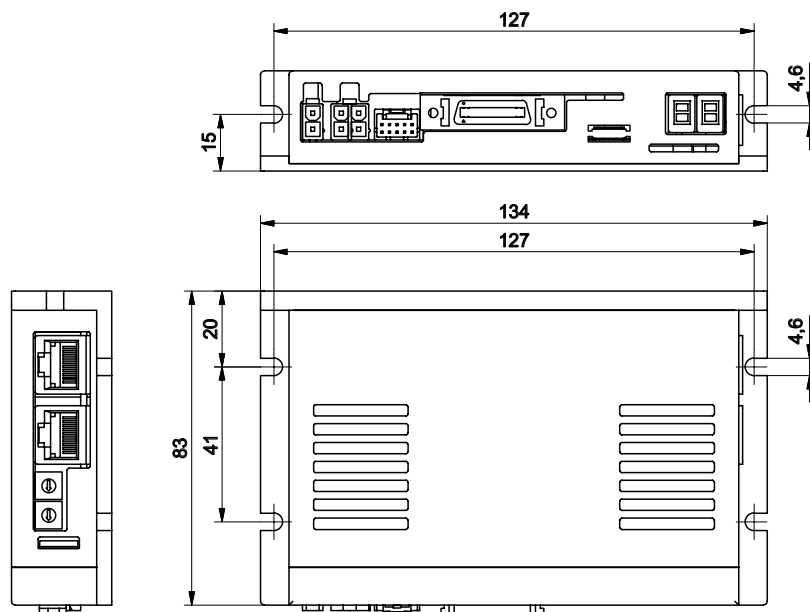

i All dimensions are in mm.
The scale of the drawings
may not be equal.

General technical data

PARAMETER	Type	Stepper drive
	Protocol/control	Ethernet
	Code	STDF-EN
	UNIT	VALUE
Operating voltage	[V DC]	24 ± 10 %
Current consumption ¹	[mA]	max. 500
Rotational speed	[rpm]	Refer to chapter. SPEED-TORQUE CHARACTERISTICS
Supported resolution ²	[ppr]	500, 1000, 1600, 2000, 3600, 5000, 7200, 10000
Input signals		3 dedicated inputs (LIMIT+, LIMIT-, ORIGIN)
		9 programmable inputs (Photocoupler)
Output signals		1 dedicated output (Compare out)
		9 programmable outputs (Photocoupler)
		Brake
Ambient temperature	[°C]	0 ~ +50
Ambient humidity	[%]	35 ~ 80 (non-condensing)
Vibration resistance	[G]	0,5
Duty cycle	[%]	100

¹ Except the motor current.

² For the case that resolution is higher than the encoder's resolution, the motor shall operate by micro-step between pulses.

Calculation of sufficient power supply:

$$P_{Wmax} = (I_d + I_{ph}) \cdot U_m$$

I_{ph}	Motor phase current	[A]
I_d	Drive current	[A]
U_m	Power supply voltage	[V]
P_{Wmax}	Maximum required power supply	[W]

i Required power supply P_w is at maximum load of the stepper motor.

Port and indicator information

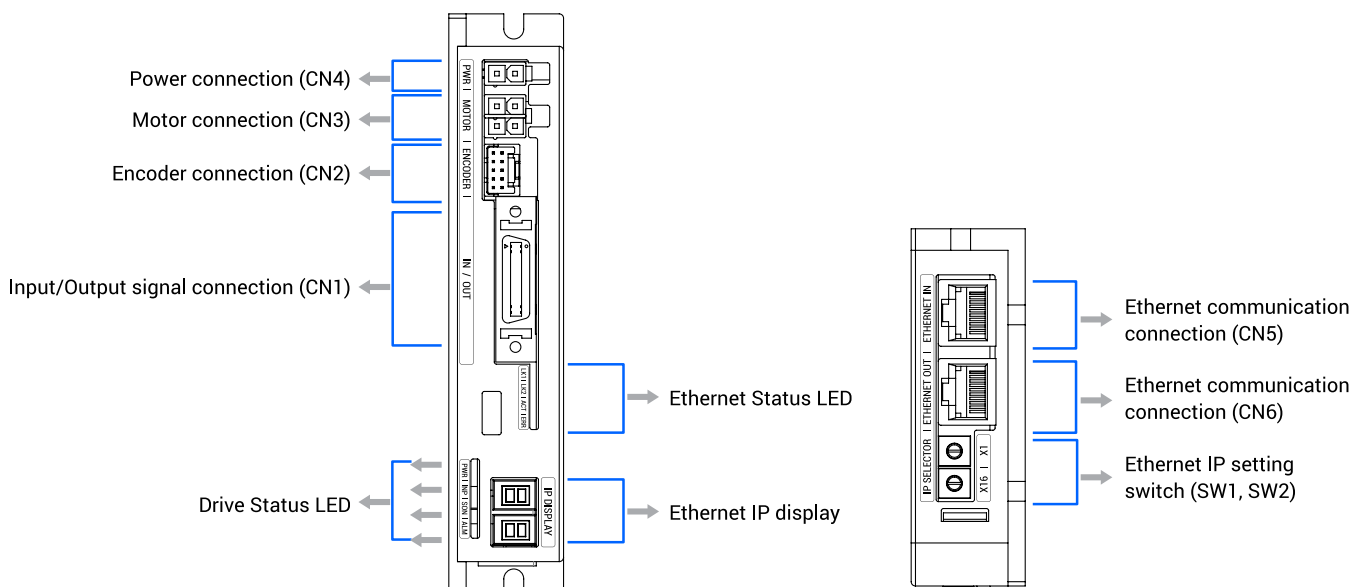

Pin layout

Input/Output signal connector (CN1):

No.	Function	I/O
1	LIMIT+	Input
2	LIMIT-	Input
3	ORIGIN	Input
4	Digital In1	Input
5	Digital In6	Input
6	Digital In7	Input
7	Compare out	Output
8	Digital Out1	Output
9	Digital Out2	Output
10	Digital Out3	Output
11	Digital Out4	Output
12	Digital Out5	Output
13	Digital Out6	Output
14	Digital In2	Input
15	Digital In3	Input
16	Digital In4	Input
17	Digital In5	Input
18	Digital In8	Input
19	Digital In9	Input
20	Digital Out7	Output
21	Digital Out8	Output
22	Digital Out9	Output
23	BRAKE+	Output
24	BRAKE-	Output
25	EXT_GND	Input
26	EXT_24VDC	Input

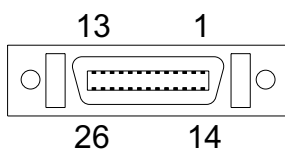

Ethernet IP display and settings switch (SW1, SW2):

The value of the fourth digit of Ethernet IP can be set through the setting switch. Set the product's IP not to overlap with other connected products. The first, second and third values of the IP can be set through the GUI. Please refer to the manual for details. When the switch is set to 255 (FF), IP is set automatically, ignoring the setting (DHCP function). The fourth digit of the Ethernet IP is displayed on the 7-Segment display.

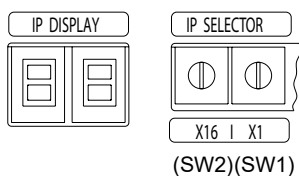

Ex) In case of Sw1 : 7 and Sw2 : 5
 $(5 \times 16) + (7 \times 1) = 87$
 IP is to be set as 192.168.0.87

Encoder connector (CN2):

No.	Function	I/O
1	A+	Input
2	A-	Input
3	B+	Input
4	B-	Input
5	I+	Input
6	I-	Input
7	5 V (DC)	Output
8	GND	Output
9	F.GND	-
10	F.GND	-

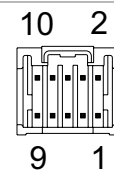

Motor connector (CN3):

No.	Function	I/O
1	A+ Phase	Output
2	B+ Phase	Output
3	A- Phase	Output
4	B- Phase	Output

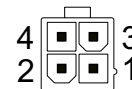

Power connector (CN4):

No.	Function	I/O
1	24 V (DC)	Input
2	GND	Input



Ethernet communication connector (CN5, CN6):

No.	Function
1	TD+
2	TD-
3	RD+
4	-
5	-
6	RD-
7	-
Connection hood	F.GND

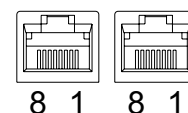

External wiring diagram

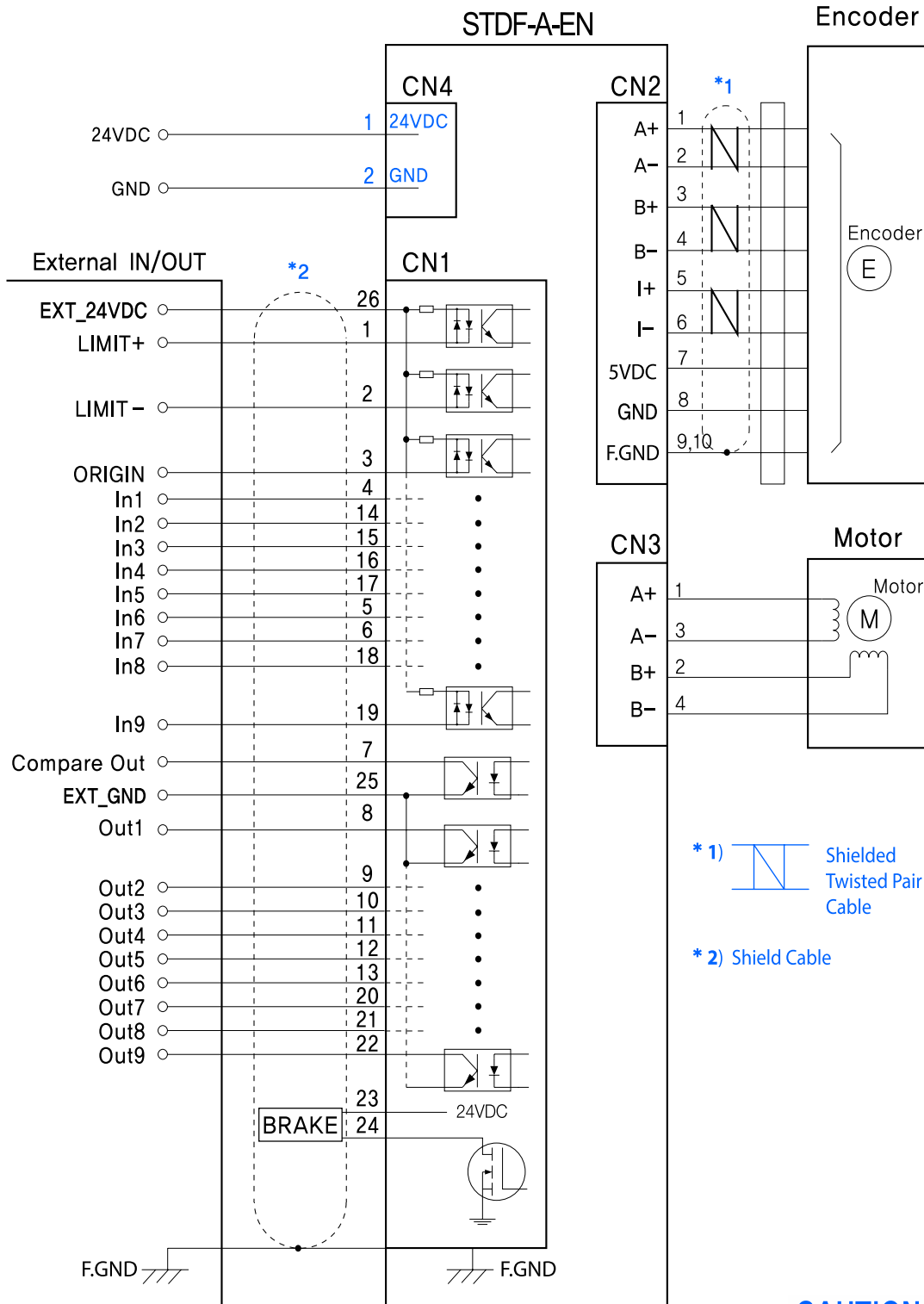

CAUTION

Please refer to the Manual when connecting the motor extension cable.
Carefull connection will be required to protect the drive from any damages.

※When connecting the I/O cables between the controller and drive, please turn off the power of both controller and drive to protect the drive from any damage.

PROFINET

Description

The drives offer Profinet IRT communication and control via Siemens Tia Portal development environment. It allows updating the set points with a cycle time of less than 1 ms. STDL-PN drives offer improved speed-torque characteristics that make this stepper system versatile and usable in many applications.

Other advantages:

- Profinet IRT communication
- Automatic Brake control
- Easy and fast mounting on the DIN rail
- Closed-loop system (errors are corrected)
- Free programming software



For configuration of the STDL drive STIL device is needed. STIL device connects to STIL port on STDL drive.



Dimensions

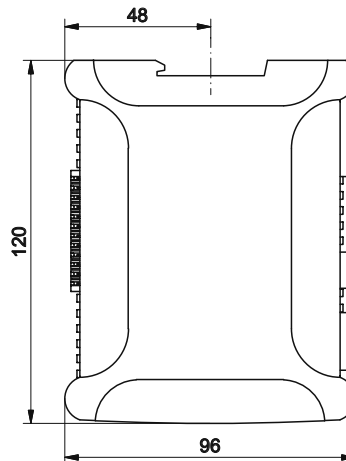
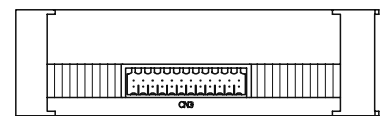
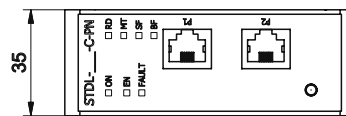
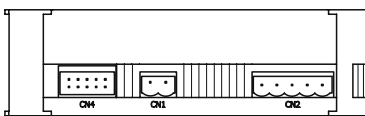

i All dimensions are in mm. The scale of the drawings may not be equal.

Technical data

PARAMETER	Type	Stepper
	Protocol/control	Profinet
	Code	STDL-040-C-PN
	UNIT	VALUE
Operating voltage	[V DC]	20 - 50
Motor current	[A]	1.0 - 4.5
Current consumption ¹	[mA]	max. 160
Rotational speed	[rpm]	Refer to chapter: SPEED-TORQUE CHARACTERISTICS
I/O signals		8 Digital inputs
		3 Digital outputs
		1 Analog input
		1 Encoder Input A, B, I
Ambient temperature	[°C]	0–40
Ambient humidity	[%]	10–90
Vibration resistance	[G]	< 1

¹ Motor current not included. @ 24 V DC

Calculation of sufficient power supply:

$$P_W = 5 + \left(1,1 \cdot (I_{ph}^2 \cdot R_{ph}) + \left| \frac{(V_{rpm} \cdot T_{nm})}{7} \right| \right)$$

I_{ph}	Motor phase current	[A]
R_{ph}	Motor phase resistance	[Ω]
V_{rpm}	Rotation speed	[rpm]
T_{nm}	Resistant torque of the load	[Nm]
P_W	Required power supply	[W]

Port information

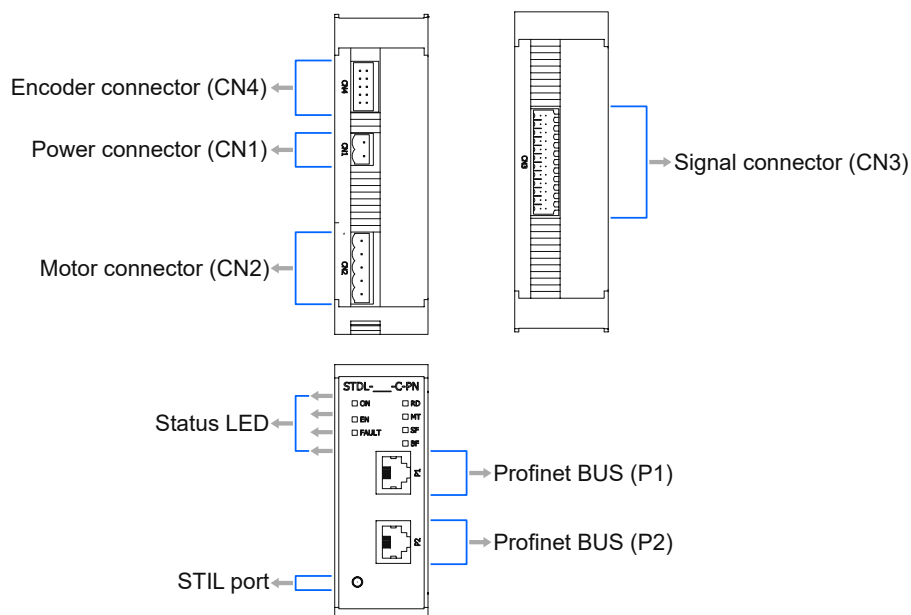

Pin layout

Power connector (CN1):

No.	Function	I/O
1	+VDC	Input
2	GND	Input



Motor connector (CN2):

No.	Function	I/O
1	A- Phase	Output
2	A+ Phase	Output
3	B+ Phase	Output
4	B- Phase	Output
5	Not connected	Output

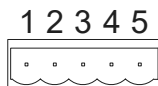

Input output signal connector (CN3):

No.	Function ²	I/O
1	+24 V (Auxiliary) ¹	Input
2	0 V (GND) (Auxiliary) ¹	Input
3	Digital In0+	Input
4	Digital In0-	Input
5	Digital In1+	Input
6	Digital In1-	Input
7	Digital common DI2..DI4	Input
8	Digital In2	Input
9	Digital In3	Input
10	Digital In4	Input
11	Digital Out0+	Output
12	Digital Out0-	Output
13	Digital Out1+	Output
14	Digital Out1-	Output
15	Analog In0+	Input
16	Analog In0 (GND)	Input
17	Digital Out2+	Output
18	Digital Out2-	Output
19	Digital common DI5..DI7	Input
20	Digital In5	Input
21	Digital In6	Input
22	Digital In7	Input

¹The auxiliary power supply is optional and, if provided, keeps the control section of the drive powered.

²The digital outputs do not have a specific functionality and their use depends on how the drive is configured. Digital output breakdown current is 120 mA.

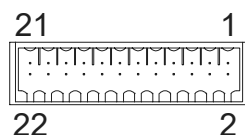

Encoder connector (CN4):

No.	Function	I/O
1	5 V (DC)	Input
2	GND	Input
3	A+	Input
4	A-	Input
5	B+	Input
6	B-	Input
7	I+	Output
8	I-	Output
9	Not used	-
10	Not used	-

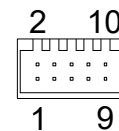

Profinet BUS (P1, P2):

The P1 and P2 connectors are used for connection to the PROFINET field bus. It is therefore possible to connect several drives in cascade without the need for external devices.

No.	Function
1	TD+
2	TD-
3	RD+
4	CT-T
5	CT-R
6	RD-
7	Not connected
8	Shield

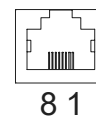

External wiring diagram

Digital inputs

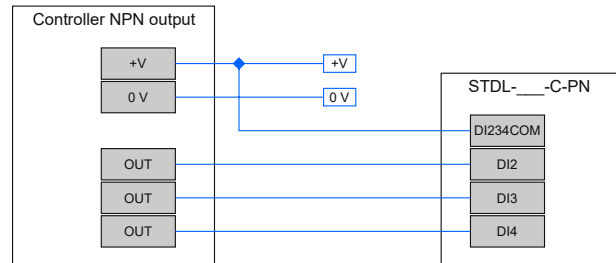
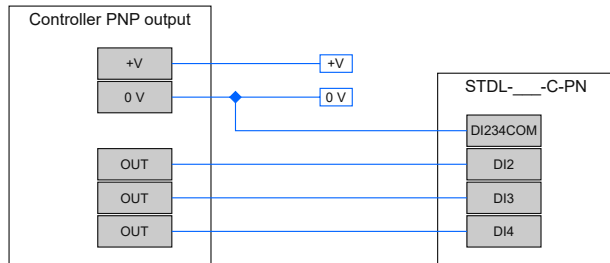

Digital outputs

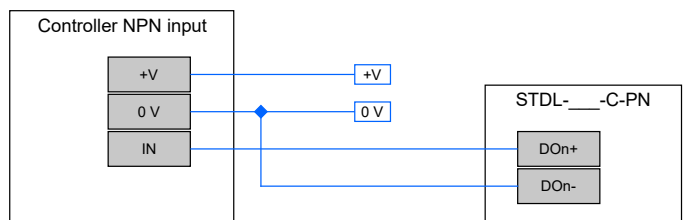
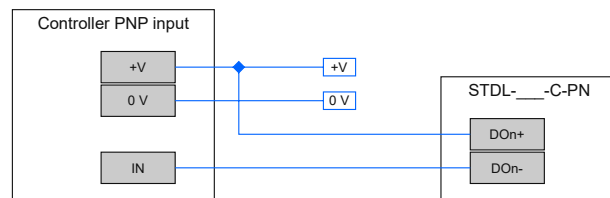

i Digital output breakdown current is 120 mA.

Brake wiring:

Brake must be wired via the relay.

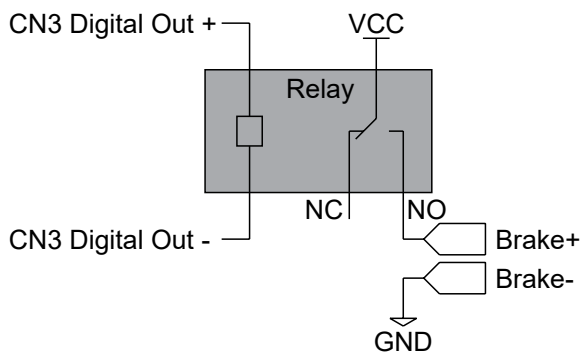

Analog input:

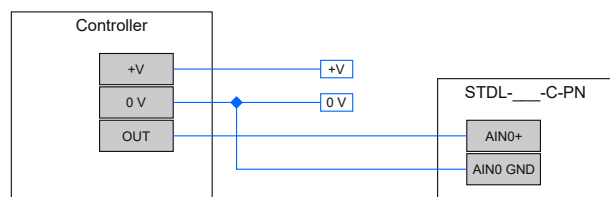

Motors

How to order	25
STMN-42-L-E(-B)	25
STMN-56-L-E(-B)	27

HOW TO ORDER

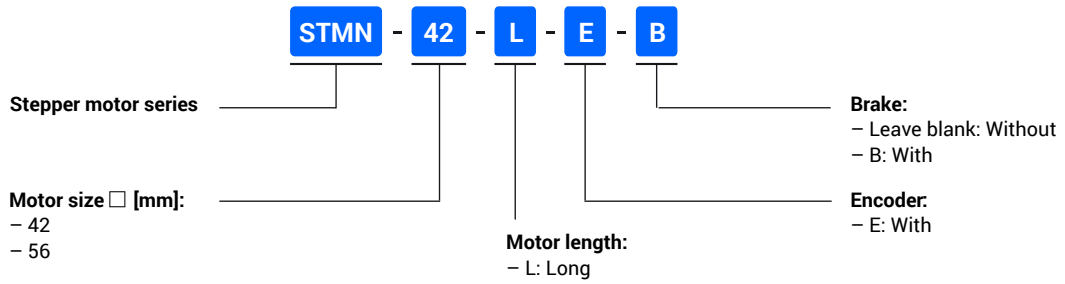

STMN-42-L-E(-B)

Description

NEMA 17 (42 mm) size stepper motor with high torque and M12 connectors offers IP65 protection (except the shaft outlet) and 1.8° step angle (full step). A motor with brake is also available.



i Motor without the brake is shown.

Dimensions

Motor without a brake:

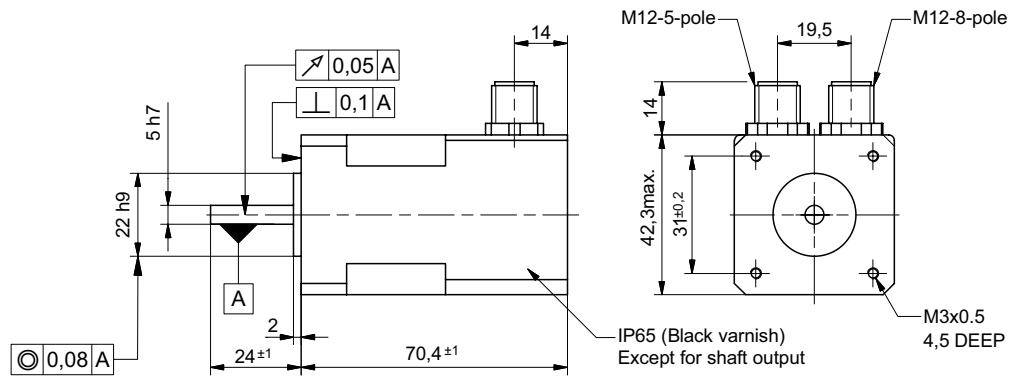

Motor with a brake:

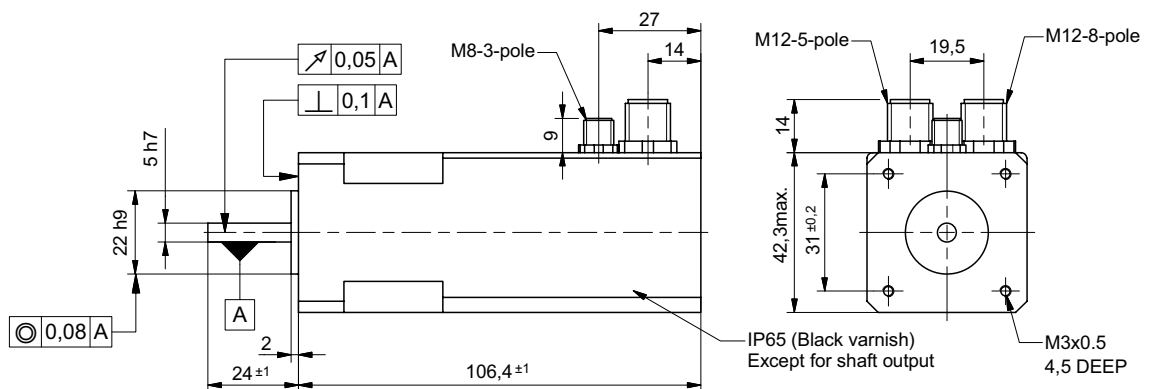

General technical data

	Parameter	Unit	Value
MOTOR	Voltage	[V DC]	3,15
	Current per phase	[A]	1,8
	Mass moment of inertia	[kg cm ²]	0,082 (0,095 ²)
	Holding torque ¹	[Nm]	0,5
	Step angle	[°]	1,8 ± 5 %
	Resistance per phase	[Ω]	1,75 ± 10 %
	Inductance per phase	[mH]	3,3 ± 20 %
	Voltage constant	$\frac{mV}{min^{-1}}$	23
	Mass	[kg]	0,44 (0,57 ²)

¹ For the speed-torque characteristic, please refer to page 6.

² For a motor with brake.

	Parameter	Unit	Value
ENCODER	Type		Incremental
	Measuring principle		Opto-electrical
	Interface		Line drive
	Resolution	[cpr/ppr]	500/2000
	Operating voltage	[V DC]	5

	Parameter	Unit	Value
BRAKE	Operating voltage	[V DC]	24 (+6/-10 %)
	Rated output	[W]	8
	Holding torque	[Nm]	0,4
	Mass moment of inertia	[kg cm ²]	0,013

¹ For a motor with brake.

	Parameter	Unit	Value
OPERATING CONDITIONS	Temperature rise: (Motor standstill; for 2 phase energized)	[°C]	max. 80
	Ambient temperature	[°C]	-10 ~ +50
	Ambient humidity	[%]	max. 85 (non-condensing)
	Protection class		IP65
	Duty cycle	[%]	100
	Insulation resistance	[MΩ]	100
	Insulation class		B (max. 130 °C)
	Dielectric strength	[V AC]	500 for 1 minute

Motor forces

Permissible loads				
Axial load F_a [N]	15			
Distance a [mm]	5	10	15	20
Radial load F_r [N]	50	36	26	20

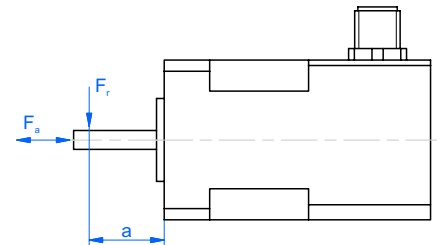

Motor pin allocation

Motor connector

Connector type: M12 5-pole

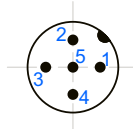

Pin	Function
1	A-
2	A+
3	B+
4	B-
5	Housing

Encoder connector

Connector type: M12 8-pole

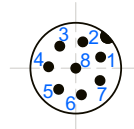

Pin	Function
1	A+
2	A-
3	B+
4	B-
5	GND
6	I-
7	I+
8	VCC (5 V)
Housing	GND/Shielding

Brake connector

Connector type: M8 3-pole

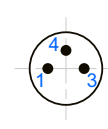

Pin	Function
1	Brake +24 V
3	Brake/GND
4	NC

i Valid only for the motors with brake: STMN-...-B

STMN-56-L-E(-B)

Description

NEMA 23 (56 mm) size stepper motor with high torque and M12 connectors offers IP65 protection (except the shaft outlet) and 1.8° step angle (full step). A motor with brake is also available.



i Motor without the brake is shown.

Dimensions

Motor without a brake:

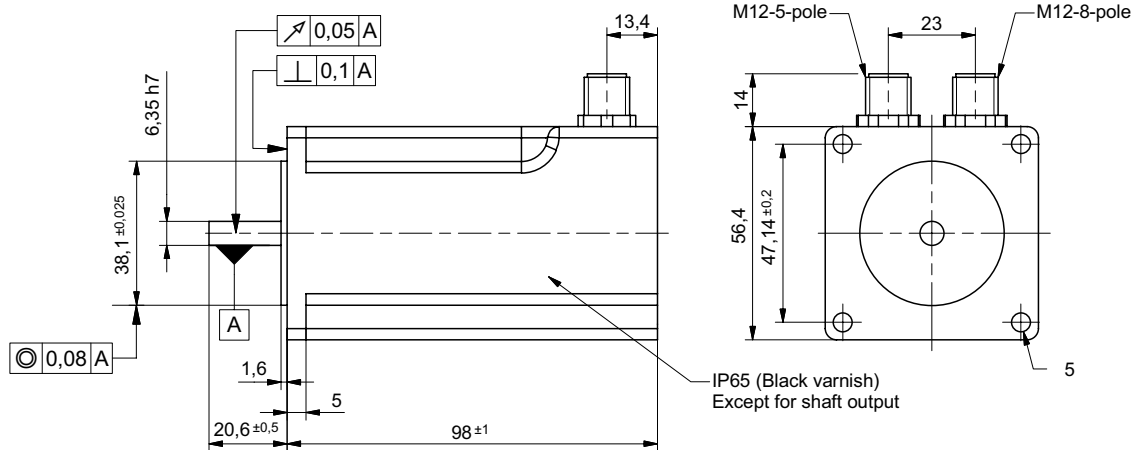

Motor with a brake:

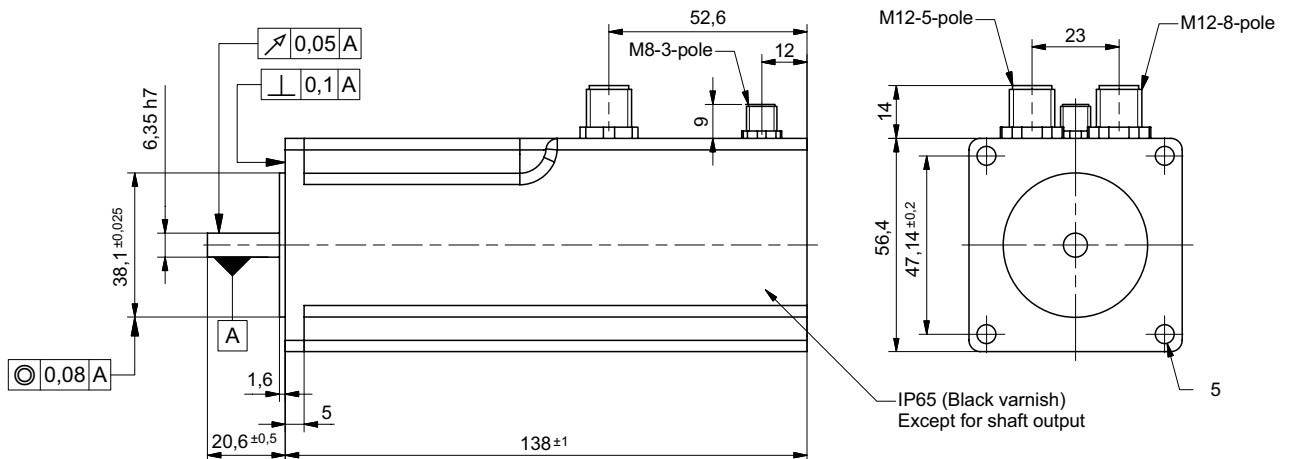

Technical data

	Parameter	Unit	Value
MOTOR	Voltage	[V DC]	2,4
	Current per phase	[A]	4,2
	Mass moment of inertia	[kg cm ²]	0,48 (0,501 ²)
	Holding torque ¹	[Nm]	1,8
	Step angle	[°]	1,8 ± 5 %
	Resistance per phase	[Ω]	0,58 ± 15 %
	Inductance per phase	[mH]	1,9 ± 20 %
	Voltage constant	$\frac{mV}{min^{-1}}$	32,5
	Mass	[kg]	1,14 (1,33 ²)

¹ For the speed-torque characteristic, please refer to page 6.

² For a motor with brake.

	Parameter	Unit	Value
ENCODER	Type		Incremental
	Measuring principle		Opto-electrical
	Interface		Line drive
	Resolution	[cpr/ppr]	500/2000
	Operating voltage	[V DC]	5

	Parameter	Unit	Value
BRAKE	Operating voltage	[V DC]	24 (+6/-10 %)
	Rated output	[W]	10
	Holding torque	[Nm]	1
	Mass moment of inertia	[kg cm ²]	0,021

¹ For a motor with brake.

	Parameter	Unit	Value
OPERATING CONDITIONS	Temperature rise: (Motor standstill; for 2 phase energized)	[°C]	max. 80
	Ambient temperature	[°C]	-10 ~ +50
	Ambient humidity	[%]	max. 85 (non-condensing)
	Protection class		IP65
	Duty cycle	[%]	100
	Insulation resistance	[MΩ]	100
	Insulation class		B (max. 130 °C)
	Dielectric strength	[V AC]	500 for 1 minute

Motor forces

Permissible loads				
Axial load F_a [N]	15			
Distance a [mm]	5	10	15	20
Radial load F_r [N]	130	90	70	52

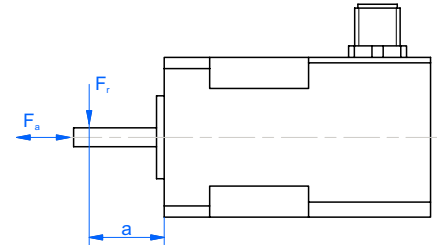

Motor pin allocation

Motor connector

Connector type: M12 5-pole

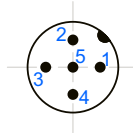

Pin	Function
1	A-
2	A+
3	B+
4	B-
5	Housing

Encoder connector

Connector type: M12 8-pole

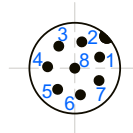

Pin	Function
1	A+
2	A-
3	B+
4	B-
5	GND
6	I-
7	I+
8	VCC (5 V)
Housing	GND/Shielding

Brake connector

Connector type: M8 3-pole

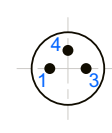

Pin	Function
1	Brake +24 V
3	Brake/GND
4	NC

i Valid only for the motors with brake: STMN-...-B

Cables

How to order	30
Power cable	31
Signal cable	31
Drive-to-motor cables	33

HOW TO ORDER

Power cables for the stepper drives (only for the STDF drives)

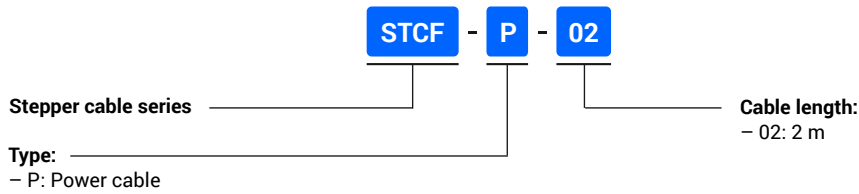

Signal cables for the stepper drives (only for the STDF drives)

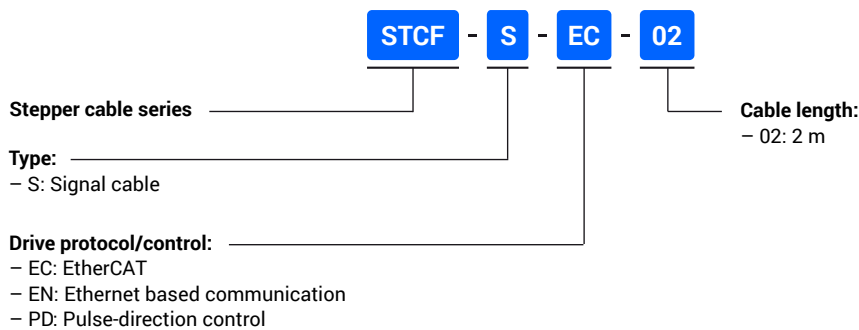

Drive-to-motor cables for the stepper motors (only for STDF/STDL drives and STMN motors)

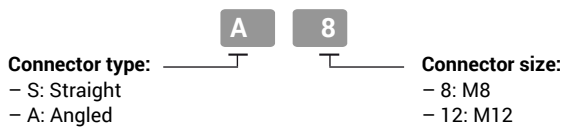
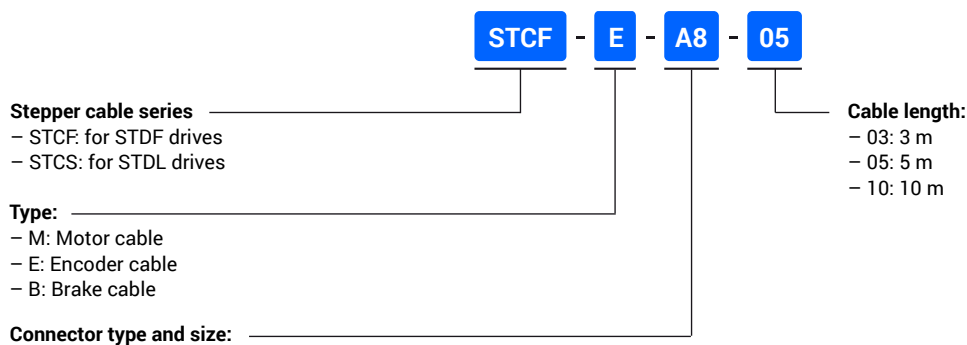

i For possible cable combinations, please refer to the table on page »5«

POWER CABLE

Connection cable between STDF drive and power supply.

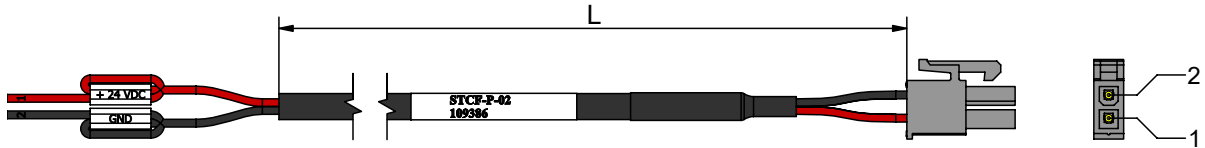

Dimensions	Power cable
	STCF-P-02
L [m]	2
ØD [mm]	4,6

Wire code	Wire designation	Pin number
Red	+24 V DC	1
Black	GND	2

SIGNAL CABLE

Connection cables between STDF drive and PLC/PC for different protocols.

Dimension	Signal cable		
	STCF-S-PD-02	STCF-S-EC-02	STCF-S-EN-02
L ¹ [m]	2		
ØD ¹ [mm]	6,4	6,4	6,9

¹ For symbol designation see the dimensional drawings of signal cables below.

Pulse-direction

Connection cable between the drive and PLC/PC for Pulse-direction based control.

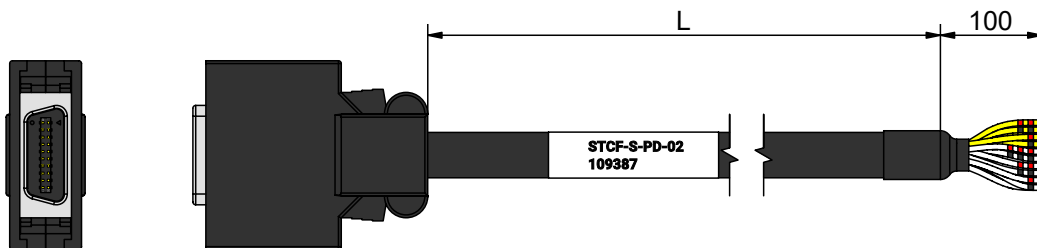

Wire colour code	Wire designation
White, 1 red dot	Pulse+
White, 1 black dot	Pulse-
White, 2 red dots	Dir+
White, 2 black dots	Dir-
White, 3 red dots	A+
White, 3 black dots	A-
White, 4 red dots	B+

Wire colour code	Wire designation
White, 4 black dots	B-
White, 5 red dots	I+
White, 5 black dots	I-
Yellow, 1 red dot	Alarm
Yellow, 1 black dot	InPosition
Yellow, 2 red dots	ServoOff
Yellow, 2 black dots	AlarmRst

Wire colour code	Wire designation
Yellow, 3 red dots	(OCInput)
Yellow, 3 black dots	Brake+
Yellow, 4 red dots	Brake-
Yellow, 4 black dots	GND_S
Yellow, 5 red dots	GND_24 V
Yellow, 5 black dots	24 V DC
Shield	/

EtherCAT

Connection cables between the drive and PLC/PC for EtherCAT communication.

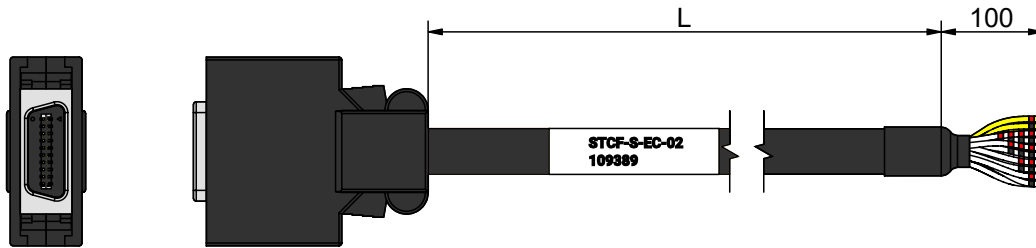

Wire colour code	Wire designation
White, 1 red dot	Limit+
White, 1 black dot	Limit-
White, 2 red dots	Origin
White, 2 black dots	In1
White, 3 red dots	In2
White, 3 black dots	In3
White, 4 red dots	In4

Wire colour code	Wire designation
White, 4 black dots	In5
White, 5 red dots	In6
White, 5 black dots	In7
Yellow, 1 red dot	Out1
Yellow, 1 black dot	Out2
Yellow, 2 red dots	Out3
Yellow, 2 black dots	Out4

Wire colour code	Wire designation
Yellow, 3 red dots	Out5
Yellow, 3 black dots	Out6
Yellow, 4 red dots	Brake+
Yellow, 4 black dots	Brake-
Yellow, 5 red dots	GND_24 V
Yellow, 5 black dots	24 V DC
Shield	/

Ethernet

Connection cables between the drive and PLC/PC for Ethernet communication.

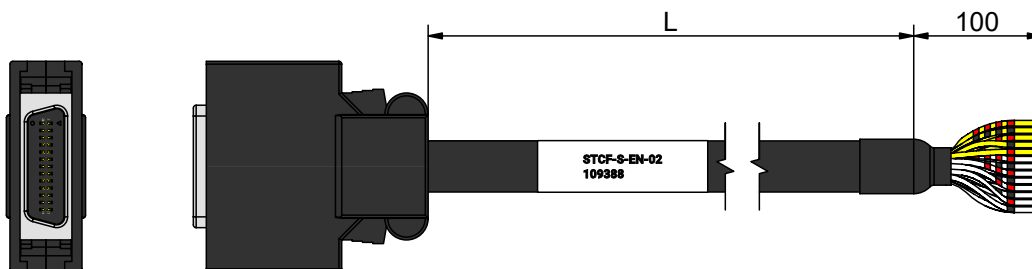

Wire colour code	Wire designation
White, 1 red dot	Limit+
White, 1 black dot	Limit-
White, 2 red dots	Origin
White, 2 black dots	In1
White, 3 red dots	In6
White, 3 black dots	In7
White, 4 red dots	CmpOut
White, 4 black dots	Out1
White, 5 red dots	Out2

Wire colour code	Wire designation
White, 5 black dots	Out3
Yellow, 1 red dot	Out4
Yellow, 1 black dot	Out5
Yellow, 2 red dots	Out6
Yellow, 2 black dots	In2
Yellow, 3 red dots	In3
Yellow, 3 black dots	In4
Yellow, 4 red dots	In5
Yellow, 4 black dots	In8

Wire colour code	Wire designation
Yellow, 5 red dots	In9
Yellow, 5 black dots	Out7
Orange, 1 red dot	Out8
Orange, 1 black dot	Out9
Orange, 2 red dots	Brake+
Orange, 2 black dots	Brake-
Orange, 3 red dots	GND_24 V
Orange, 3 black dots	24 V DC
Shield	/

DRIVE-TO-MOTOR CABLES

Drive-to-motor cables include encoder, motor and brake cables. All the cables are flexible and can be used in combination with energy chains. Available lengths of the cables are 3 m, 5 m or 10 m.

Technical data

Type	Code	Diameter	Length [m]	Min. bending [mm]	Temperature range	
					Fixed [°C]	Flexing [°C]
Encoder	STCF-E-A12-xx	6,7	3/5/10	50,25	-40/+70	+5/+70
	STCF-E-S12-xx	6,7		63	-20/+80	-25/+60
	STCS-E-A12-xx	6,3				
	STCS-E-S12-xx	6,3				
Motor	STCF-M-A12-xx	5,1		38,25	-40/+70	+5/+70
	STCF-M-S12-xx	5,1		57	-20/+80	-25/+60
	STCS-M-A12-xx	5,7				
	STCS-M-S12-xx	5,7				
Brake	STCF-B-A8-xx	4,5		33,72	-40/+70	+5/+70
	STCF-B-S8-xx	4,5		45	-20/+80	-5/+60
	STCS-B-A8-xx	4,5				
	STCS-B-S8-xx	4,5				

Encoder cable

Connection cables between the drive and motor encoder. Available with a straight and angled M12 connector on the encoder side. An angled connector is always positioned towards the shaft of the motor.

STCF-E-A12-xx/ STCF-E-S12-xx (for STDF drives)

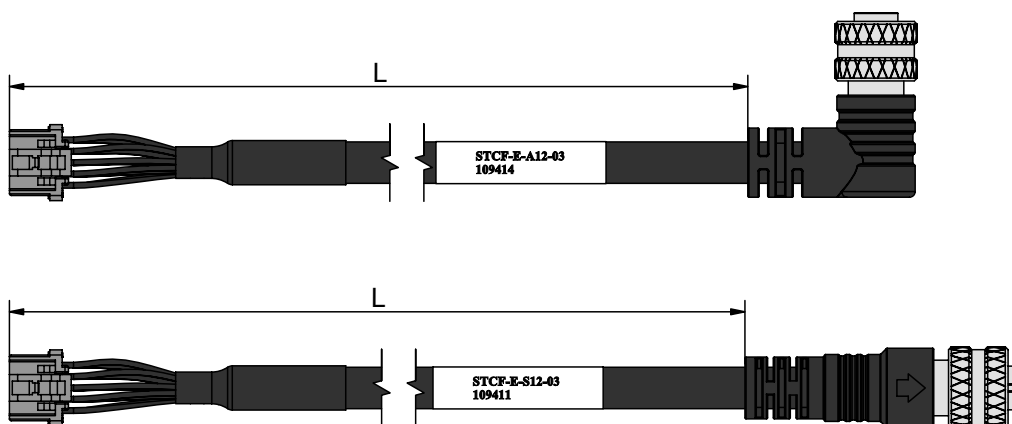

STCS-E-A12-xx/ STCS-E-S12-xx (for STDL drives)

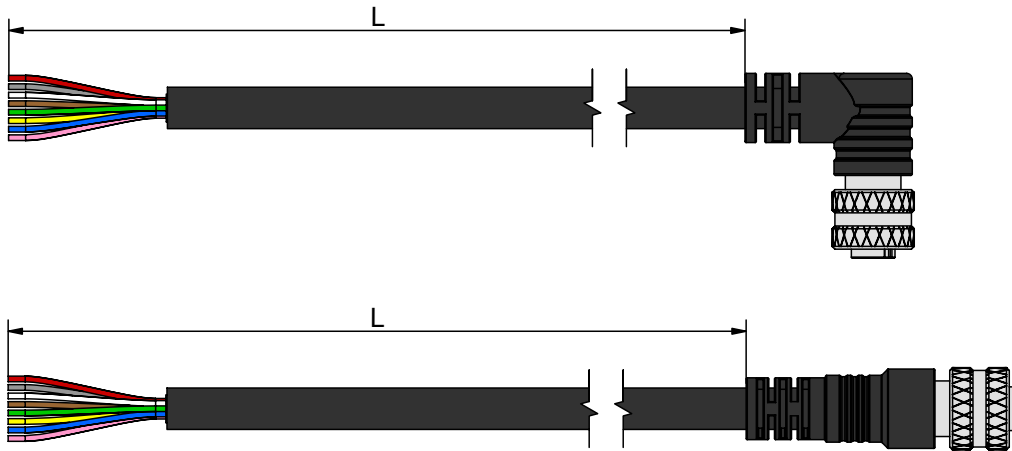

Cable pin allocation:

Pin number	Wire colour
1	white
2	brown
3	green
4	yellow
5	gray
6	pink
7	blue
8	red

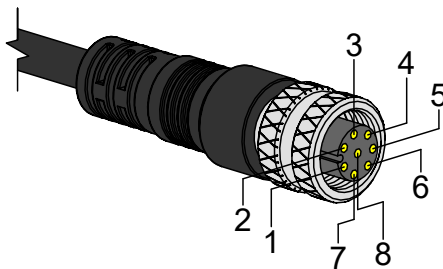

Motor cable

Connection cables between the drive and motor. Available with a straight and angled M12 connector on the motor side. An angled connector is always positioned towards the shaft of the motor.

STCF-M-A12-xx/ STCF-M-S12-xx (for STDF drives)

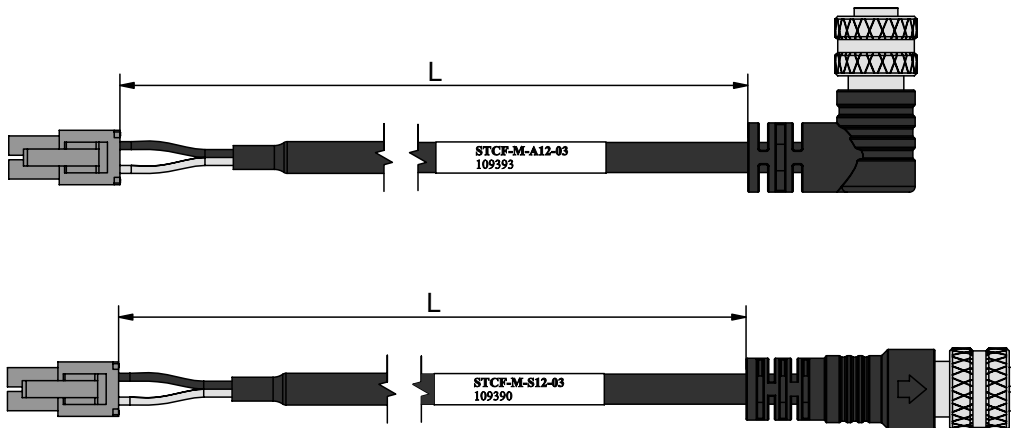

STCS-M-A12-xx/ STCS-M-S12-xx (for STD L drives)

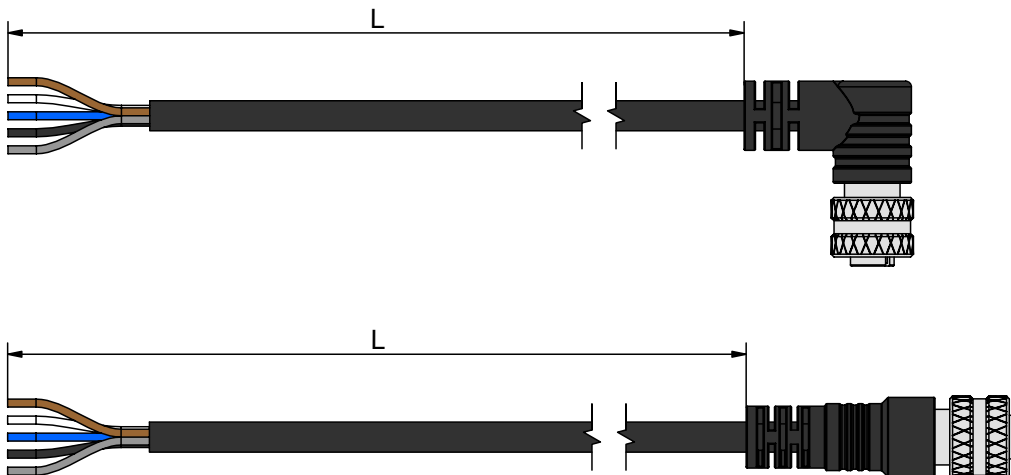

Cable pin allocation:

Pin number	Wire colour
1	brown
2	white
3	blue
4	black
5	gray

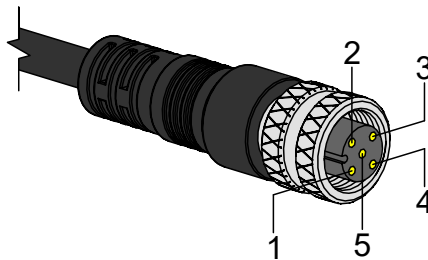

Brake cable

Connection cables between the drive and brake. Available with a straight and angled M8 connector on the motor side. Only for the motors with brake. An angled connector is always positioned towards the shaft of the motor.

STCF-B-A8-xx / STCF-B-S8-xx (for STDF drives)

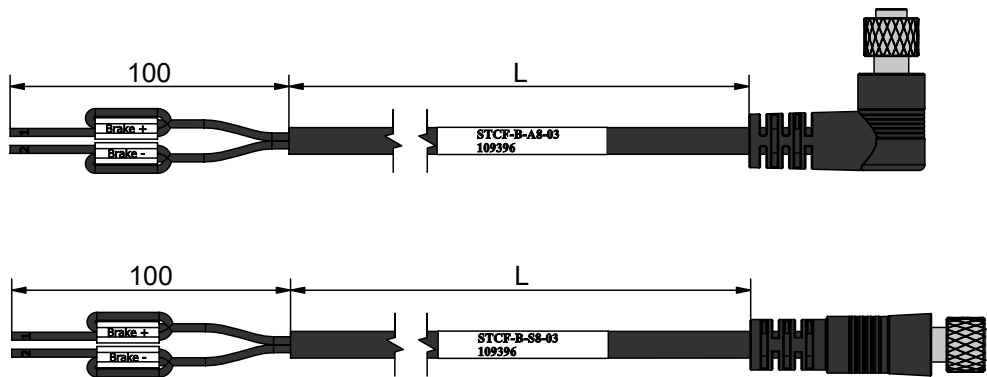

STCS-B-A8-xx / STCS-B-S8-xx (for STDL drives)

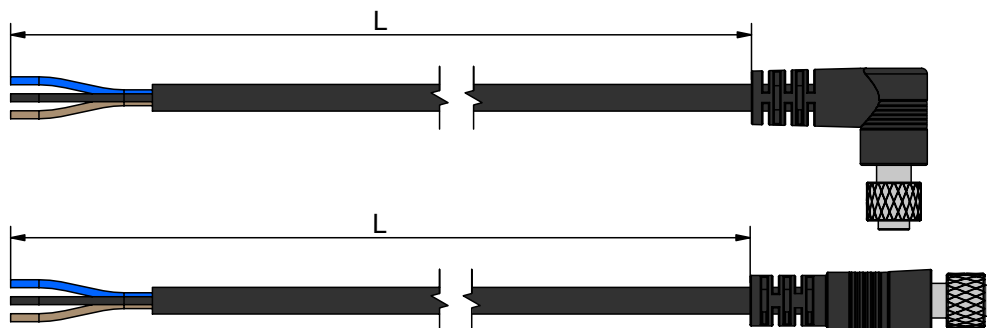

Cable pin allocation:

Pin number	Wire colour
1	brown
3	blue
4	black

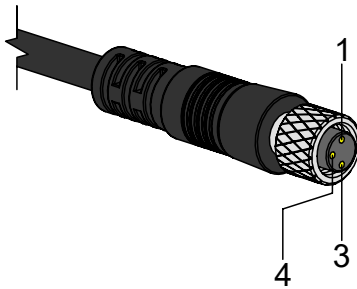

Connector dimensions

In the table below the dimensions of the connector cables in reference to the motors are presented.

Connector size	Straight	Angular	
	L1	L2	L3
M8	47	31	26
M12	55,5	40	31

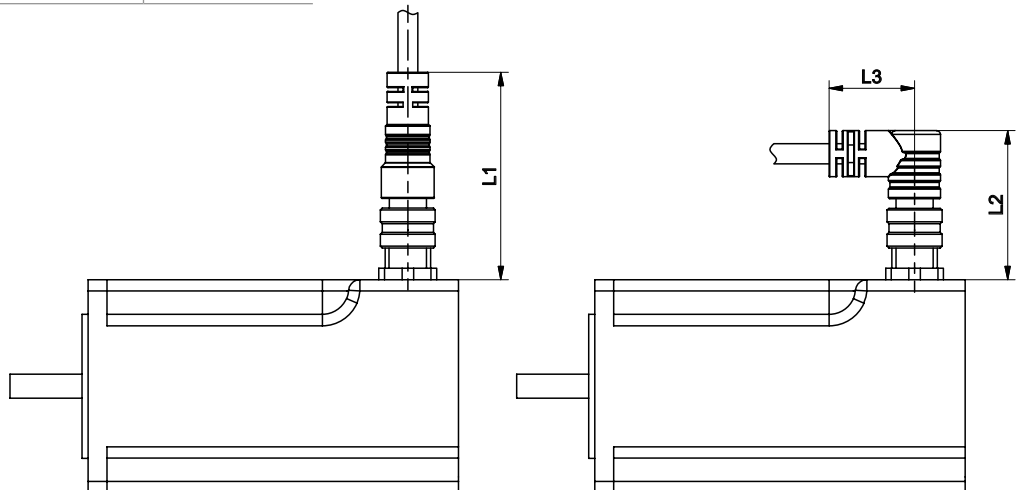

UNIMOTION



We cover all major markets. If you wish to contact us, send us an enquiry and we would be happy to assist you.

GERMANY

Unimotion GmbH
Walramstraße 23
D-65510 Idstein

T +49 (0) 7404 4711 155
F +49 (0) 7404 930 85 60

www.unimotion.de
vertrieb@unimotion.de

NORTH AMERICA

Unimotion North America, Inc.
3952 Ben Hur Ave, Unit 5
Willoughby, OH 44094

T: +1 440-525-9106

www.unimotionusa.com
info@unimotionusa.com